



# MIC2250 Evaluation Board

## High Efficiency, Low EMI Boost Regulator

### General Description

The MIC2250, a high efficiency, low EMI boost regulator is optimized for noise sensitive hand held battery powered applications. The proprietary control method allows low ripple across the output voltage and current ranges. Additionally, the MIC2250's DITH function introduces a pseudo-random dithering of the switching frequency to reduce EMI levels by up to 10dB. The MIC2250 operates from an input voltage range of 2.5 to 5.5V.

This board enables the evaluation of the MIC2250, a fully integrated, general purpose boost regulator with high efficiency over a wide load range. The board includes jumpers to allow manual setting of enable and dither functions.

Data sheets and support documentation can be found on Micrel's web site at [www.micrel.com](http://www.micrel.com).

### Requirements

The MIC2250 evaluation board requires an input power source that is able to deliver at least 3A over the desired input voltage range. For the load, a 10W, variable resistor is recommended or an electronic load (E-Load) capable of constant resistance setting can be used. Note that noise/EMI measurements must employ a resistive load as electronic loads can introduce noise at light loads.

### Precautions

The evaluation board does not have reverse polarity protection. Applying a negative voltage to the VIN terminal may damage the device.

If the source cables are greater than 10cm long, an additional input bulk capacitance is recommended to offset any inductive components introduced by the cables. In most instances, a 100uF Tantalum capacitor is sufficient.

The MIC2250 has a maximum input voltage rating of 6V therefore the supply voltage should never exceed this value.

### Getting Started

1. Connect the input supply to the input terminals. Take note of the polarity to prevent damage. An ammeter can be used in-line with the VIN terminal to measure input current. The Input voltage should be measured at the input terminal to account for losses in the test leads and ammeter.

2. Connect a load. Ensuring the Enable jumper (Ena) is in the open position; connect the load to the output terminals: Vo connects to the positive E-Load input or center/wiper connection of a variable resistor, GND connects to the negative E-Load input or the fixed end of a variable resistor.

A low impedance ammeter can be connected in-line with the Vo terminal for current measurements. The output voltage should be measured at the evaluation board terminals Vo and GND to measure converter efficiency.

3. Select DITH operation. The evaluation board is provided with a 100k (R4) pull-down resistor connected to the DITH pin. The pull-down resistor will disable the dither function, to enable dithering, simply connect a jumper across the DITH pin header. The DITH pin should not be left floating, removing the DITH jumper and pull-down resistor will cause the MIC2250 to operate in an unknown state.

4. Power and Enable the MIC2250. Turn on the input supply and E-load (if applicable). Note that Vin minus one diode drop will be seen at the output terminals, this is expected as the Schottky diode D1 always connects Vin to Vout.

The evaluation board is provided with a 100k (R3) pull-down resistor connected to the enable pin. The pull-down resistor provides a default disable state to the MIC2250 until a jumper is connected across the ENA pin header. The EN pin can not be left floating, removing the pull-down resistor, R3, and jumper will cause the MIC2250 to operate in an indeterminate state.

### Ordering Information

Part Number	Description
MIC2250YML EV	High Efficiency, Low EMI Boost Regulator Evaluation Board

## Evaluation Board Description

By default, the board includes feedback resistors set to give a nominal voltage of 15V at up to 300mA. The output voltage can be set between the limits of VIN and 32V. A list of common voltages and suitable components are shown below.

V <sub>OUT</sub>	R1	R2
5V	90.9k	30.1k
9V	102k	16.2k
12V	243k	28k
15V	910k	82k
18V	1.07M	78.7k
24V	1.37M	75k
30	1.47M	63.4k

The equation for calculating R2 given a particular value of R1 and desired output voltage is:

$$R2 = R1 \times \frac{1}{\frac{V_{OUT}}{1.24V} - 1}$$

The suggested values for R1 are shown below. In situations where the input voltage is less than 5V, a feedforward capacitor may be added to improve transient performance.

V <sub>OUT</sub>	Suggested max. R1	C <sub>FF</sub>
5V ≤ V <sub>OUT</sub> < 10V	~100kΩ	4.7nF
10V ≤ V <sub>OUT</sub> < 15V	~240kΩ	2.2nF
15V ≤ V <sub>OUT</sub> < 32V	~1.5MΩ	470pF

### Diode selection

For most applications with output voltages under 12V, a Schottky diode is recommended. However, at higher output voltages, a standard diode may deliver greater efficiency. This is due to the higher reverse leakage current of a Schottky diode becoming significant at higher voltages and especially at high operating temperatures.

# Evaluation Board Performance

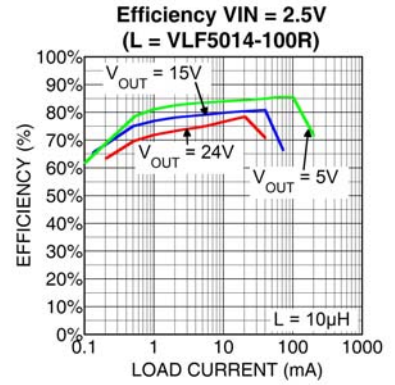
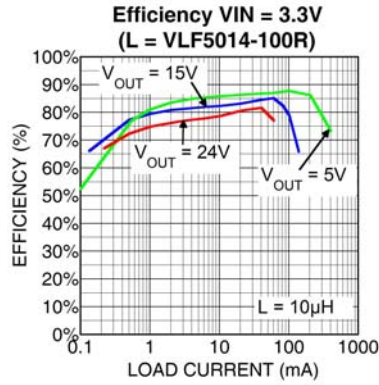
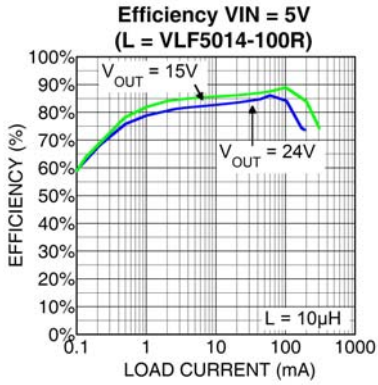

## Start-up

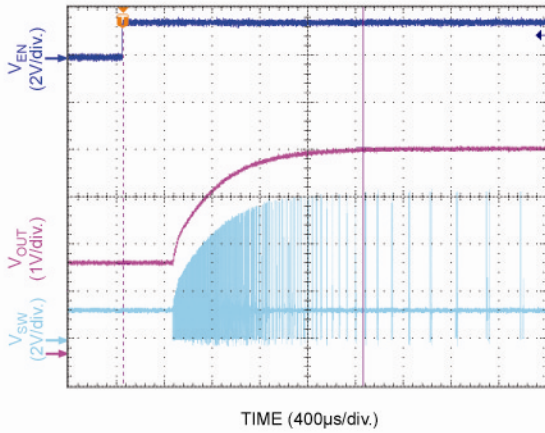

## Transient Response 1mA to 100mA Step

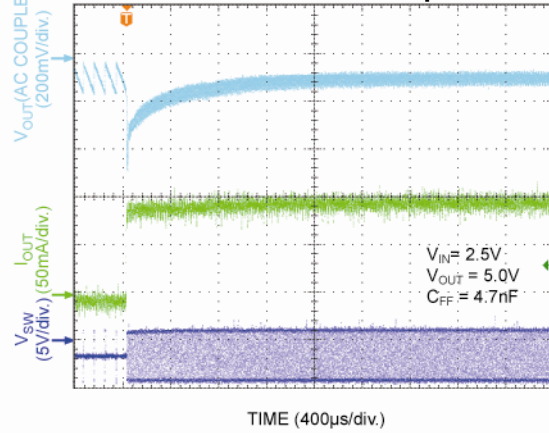

## Transient Response 100mA to 1mA Step

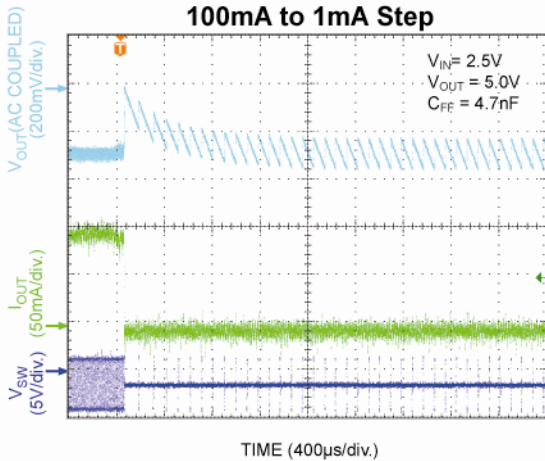

## Switching Waveforms

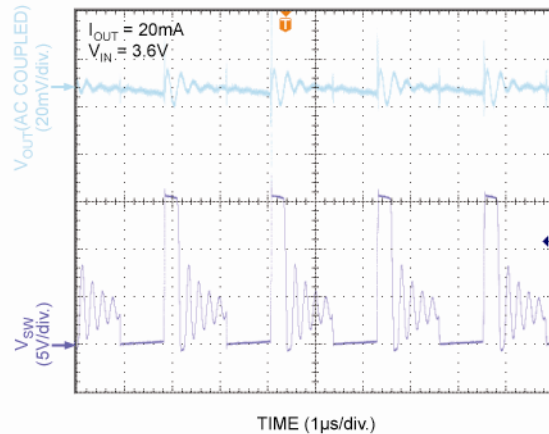

### Enable Into Current Limit

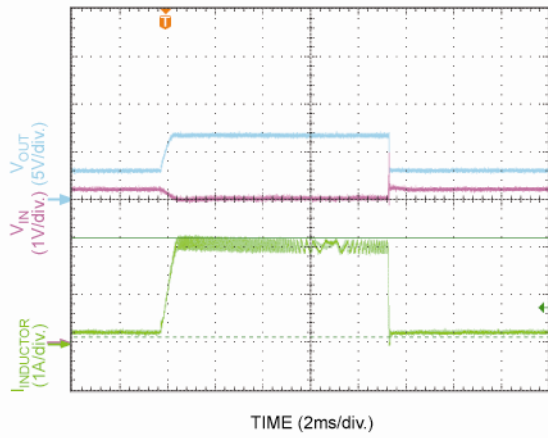

## Evaluation Board Schematic

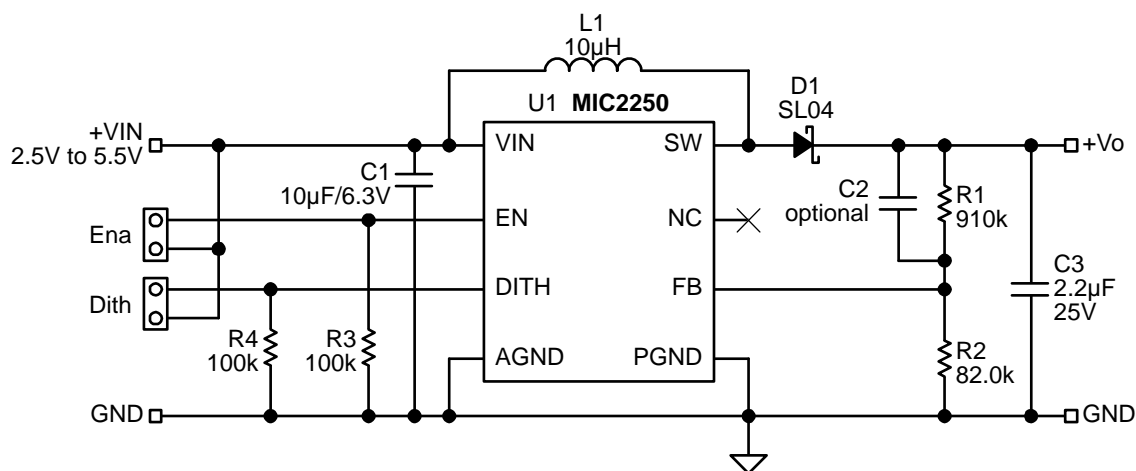

## Bill of Materials

Item	Part number	Manufacturer	Description	Quantity
C1	GRM21BR60J106M	Murata <sup>(1)</sup>	Capacitor, 10uF, 6.3V, X5R, size 0805	1
	C2012X5R0J106K	TDK <sup>(2)</sup>		
	08056D106KAT	AVX <sup>(3)</sup>		
	VJ0805G106KXYAT	Vishay <sup>(4)</sup>		
C2				Optional
C3	GRM21BR61E225KA12L	Murata <sup>(1)</sup>	Capacitor, 2.2uF, 25V, X5R, size 0805	1
	08053C225MAT	AVX <sup>(3)</sup>		
	C2012X5R1E225K	TDK <sup>(2)</sup>		
D1	SL04	Vishay <sup>(4)</sup>	Schottky diode, 40V, 1A, size SMF	1
L1	VLF5014AT-100MR92	TDK <sup>(2)</sup>	Inductor, 10uH, 1.1A, 4.5x4.5x1.4mm	1
	LPS4018-103MLB	Coilcraft <sup>(5)</sup>	Inductor, 10uH, 1.3A, 3.9x3.9x1.7mm	
	CDRH4D28C-100NC	Sumida <sup>(6)</sup>	Inductor, 10uH, 1.25A, 5.1x5.1x3mm	
R1	CRCW0603910KFKEYE3	Vishay Dale <sup>(4)</sup>	Resistor, 910K, 1%, 1/16W, size 0603	1
R2	CRCW060382K0FKEYE3	Vishay Dale <sup>(4)</sup>	Resistor, 82K, 1%, 1/16W, size 0603	1
R3,R4	CRCW06031003FKEYE3	Vishay Dale <sup>(4)</sup>	Resistor, 100K, 1%, 1/16W, size 0603	2
U1	<b>MIC2250YML</b>	<b>Micrel, Inc<sup>(7)</sup></b>	High Efficiency, Low EMI boost regulator	<b>1</b>

### Notes:

1. Murata: [www.murata.com](http://www.murata.com)
2. TDK: [www.tdk.com](http://www.tdk.com)
3. AVX: [www.avx.com](http://www.avx.com)
4. Vishay: [www.vishay.com](http://www.vishay.com)
5. Coilcraft: [www.coilcraft.com](http://www.coilcraft.com)
6. Sumida: [www.sumida.com](http://www.sumida.com)
7. Micrel, Inc.: [www.micrel.com](http://www.micrel.com)

**PCB Layout**

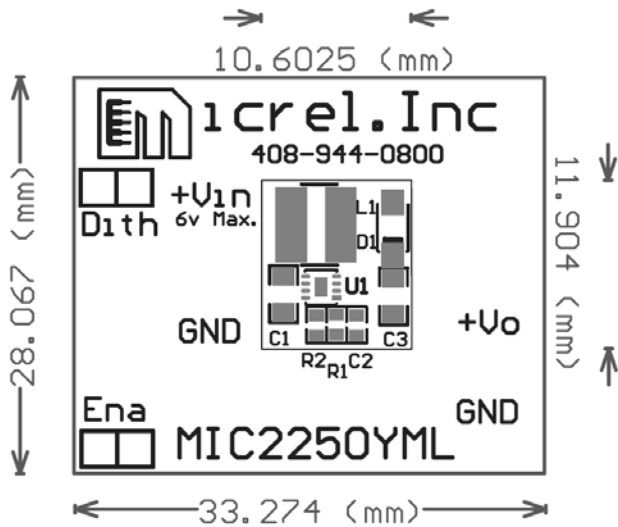

**Top Silkscreen**

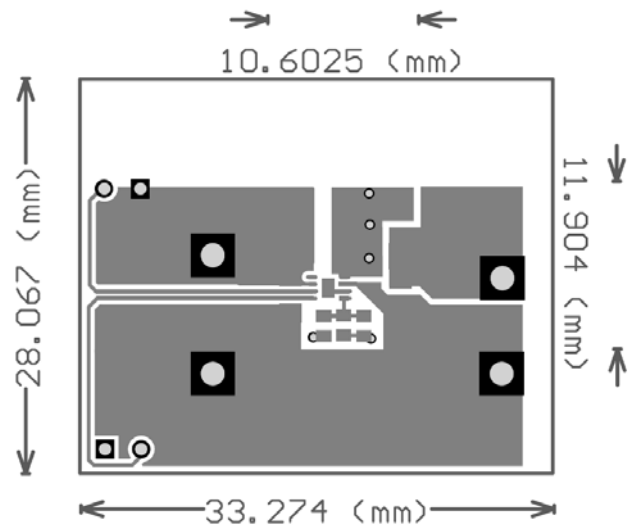

**Top Layer**

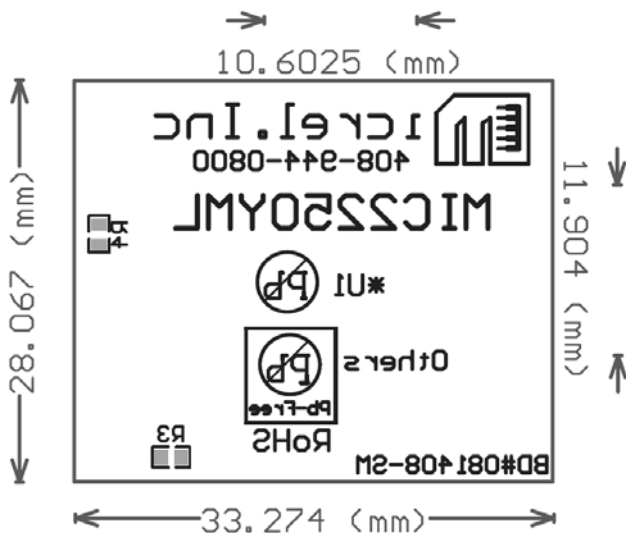

**Bottom Silkscreen**

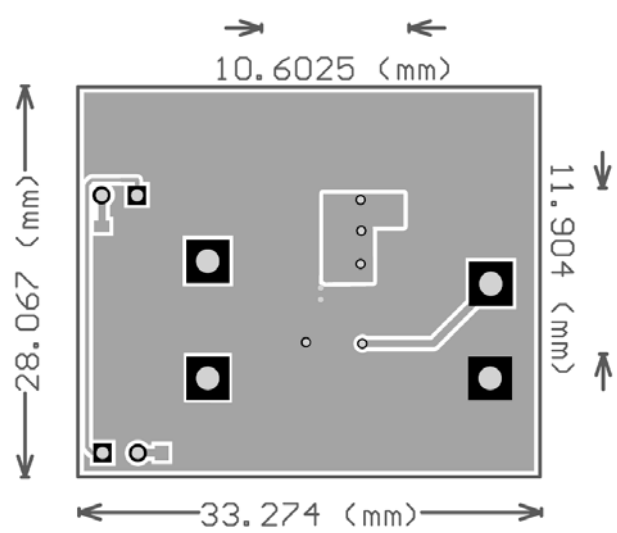

**Bottom Layer**

**MICREL, INC. 2180 FORTUNE DRIVE SAN JOSE, CA 95131 USA**  
 TEL +1 (408) 944-0800 FAX +1 (408) 474-1000 WEB <http://www.micrel.com>

The information furnished by Micrel in this data sheet is believed to be accurate and reliable. However, no responsibility is assumed by Micrel for its use. Micrel reserves the right to change circuitry and specifications at any time without notification to the customer.

Micrel Products are not designed or authorized for use as components in life support appliances, devices or systems where malfunction of a product can reasonably be expected to result in personal injury. Life support devices or systems are devices or systems that (a) are intended for surgical implant into the body or (b) support or sustain life, and whose failure to perform can be reasonably expected to result in a significant injury to the user. A Purchaser's use or sale of Micrel Products for use in life support appliances, devices or systems is a Purchaser's own risk and Purchaser agrees to fully indemnify Micrel for any damages resulting from such use or sale.

© 2006 Micrel, Incorporated.